

ropimex®



Screen-Systems

HealthCare - since 1976



disinfectable
washable



disinfectable
washable



Telescopic screens



Vario rail system



Telescopic screen cubicles

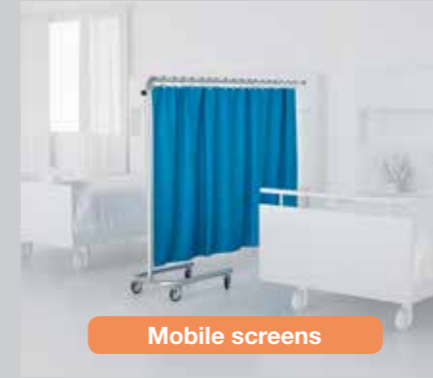

Mobile screens

disinfectable

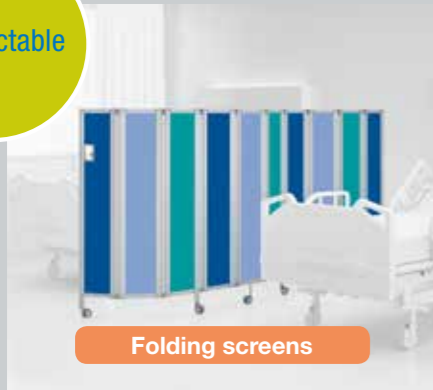

Folding screens



Paravents



Folding Curtain PLiO

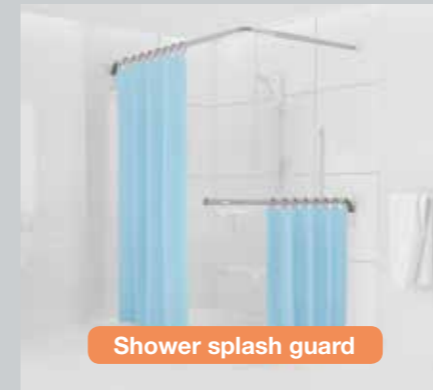

Shower splash guard

ropimex® HyGentle®

Product design and material combination for maximum hygiene

Product design:

Hygiene starts with the design. Corners, angles or geometries that are ill-suited for cleaning and disinfection are avoided to the greatest possible extent.

Material composition:

Cleanability and disinfectability are prioritized in the selection of the materials required for manufacturing the product. This is aimed at achieving an optimum where soiling and microbiological pollution are concerned. Porous, absorbent surfaces must be avoided.

Cleaning and disinfection:

We test and document the materials of our products in terms of their natural microbial contamination, just as we document their cleanability and disinfectability with commercially available detergents and disinfectants.

For your safety:

ropimex® products conform to the highest safety standards. The telescopic screens including the trolley, the Vario rail system and the folding screens all bear the GS tested safety mark issued by the German TÜV (technical inspectorate).



disinfectable
washable

Curtains

disinfectable
washable

Telescopic screens, Telescopic arms 4 - 13

Wall brackets /
Brackets for equipment rails 14 - 15

Mobile screens 16 - 17

Vario rail system 18 - 21

Curtains 22 - 25

disinfectable

Folding screens 26 - 39

Paravents 40 - 45

Folding Curtain PLiO 46 - 49

Shower splash guard 50 - 51

About us / For your safety /
Certificates 52 - 53



Ideal for all areas

- 1 Shower splash guard and Butterfly-Folding screen
- 2 Telescopic screens
- 3 Telescopic screens cubicles
- 4 Folding screens
- 5 Vario rail system
- 6 Folding screens DIVI max
- 7 Folding Curtain
- 8 Paravents

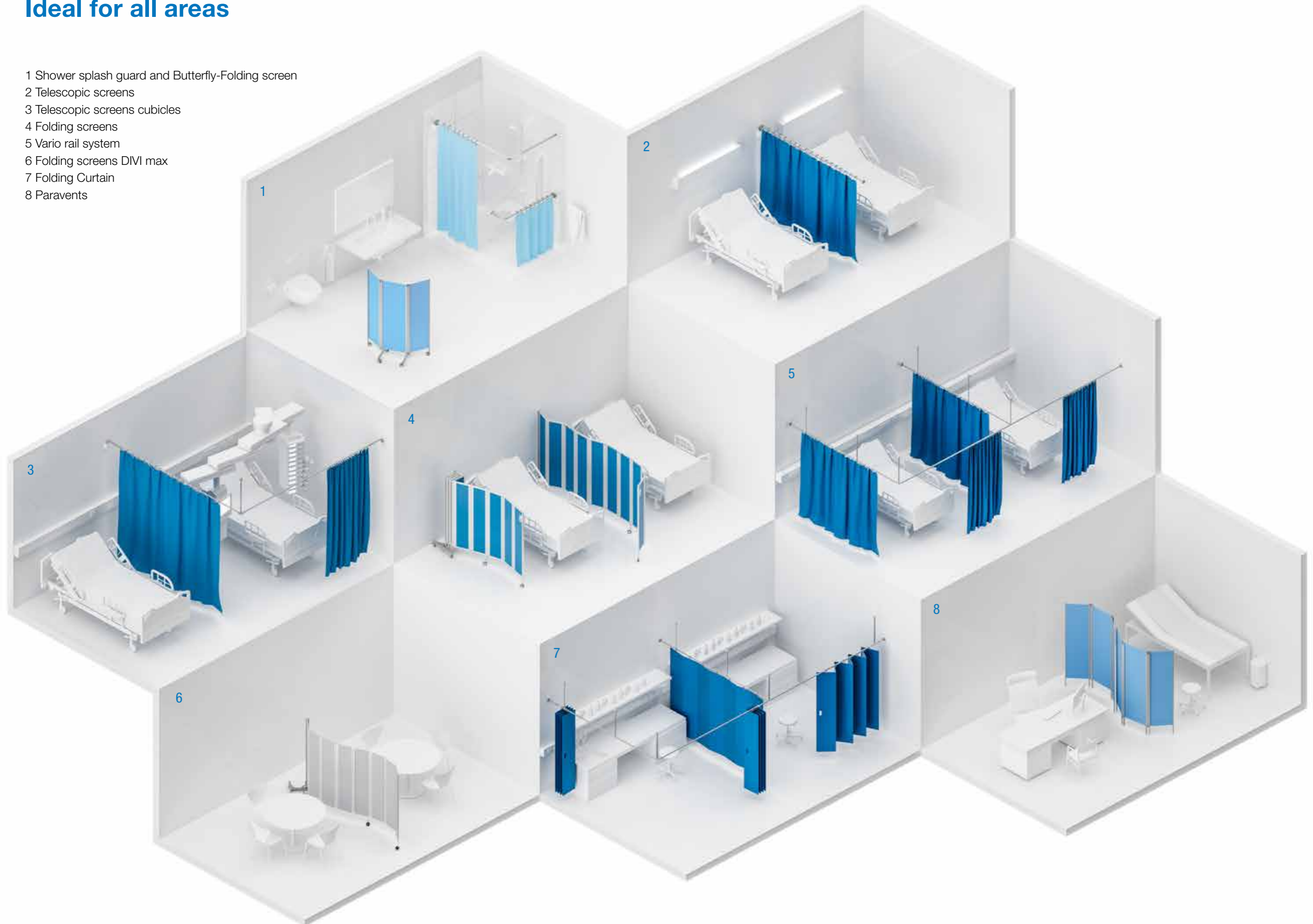

Telescopes of the new generation



ropimex® HyGentle®: Product design and material combination for maximum hygiene

The ropimex® telescopes of the new generation are optimized in handling, cleaning and disinfection by means of seamlessly integrated mechanics and particularly smooth, hygiene-friendly surfaces. ropimex® curtains, washable and disinfectable complete the hygiene concept.



Smooth telescopic tubes and Plastics for one hygiene-friendly surface.



Bending mechanism seamlessly integrated.



Integrated stop mechanism for the curtain rings



Tail with Locking - fixed telescope at rest



If the curtain rings are loaded they release themselves from the eyelets of the curtains and therefore avoid injuries and damage to the system.

Cleanique

Cleanique® seamless curtain see page 23



Direct to the product video



Telescopic screens



Model RTS:
swing-out



Model RTI:
fold-down and
swing-out



Model RTH:
with hooks, fold-down
and swing-out

You can't trip over things that hang on the wall. Which is why we created ropimex® telescopic screens, the screen that's only there when it's needed. After use, simply push the screen together and turn it towards the wall. Your room is back to looking its familiar self.



Telescopic screens

RTS

swing-out
- self-supporting -



telescopes disinfectable

Curtains with disinfectant washable

Recommended curtains (see p. 22-23)

Trevira®CS Bioactive

Cleanique®



RTS models in the doctor's surgery

RTS models in the retirement and care home
One telescopic screen can be used to screen off several beds, which have been previously fitted with brackets

RTS: Telescopic screen, swing-out, self-supporting

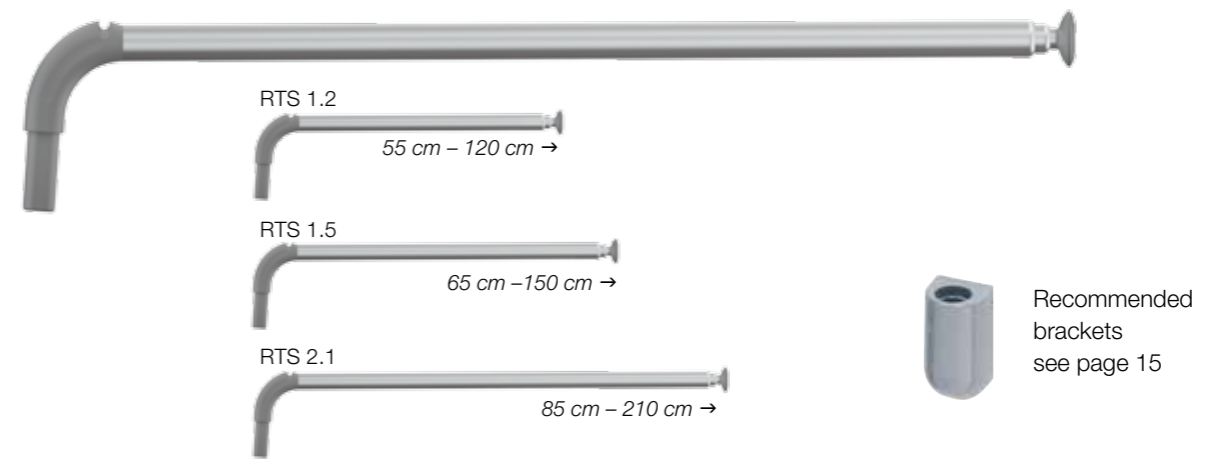

Material

ropimex® telescopic screens are made of anodised aluminium, high-quality, glass-fibre reinforced plastics. Easy to clean and to disinfect.



Model	Telescopic screen extension	Weight	Rings	Recommended curtains (see p. 22-23)
RTS 1.2	120 cm	0,5 kg	10	TCS 121, TCS 122, TCS 123, CQ 121, CQ 122
RTS 1.5	150 cm	0,6 kg	13	TCS 151, TCS 152, TCS 153, CQ 151, CQ 152
RTS 2.1	210 cm	0,7 kg	17	TCS 211, TCS 212, TCS 213, CQ 211, CQ 212

VR: Curtain rings



ropimex® curtain rings are always included with telescopic screens, telescopic arms and telescopic screen cubicles. Curtain rings can also be supplied separately. Standard colour: grey.



If they are loaded they release themselves from the eyelets of the curtains and therefore avoid injuries and damage to the system.

Telescopic screens

RTI

fold-down and swing-out
- self-supporting -

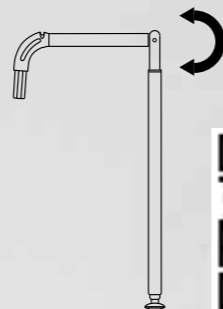
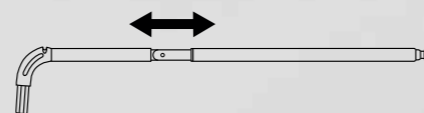
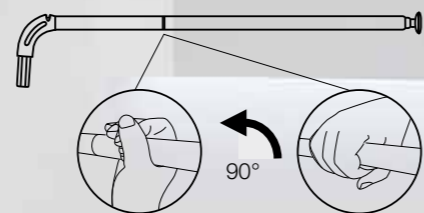

Direct to the product video

Recommended curtains (see p. 22-23)

Trevira®CS Bioactive

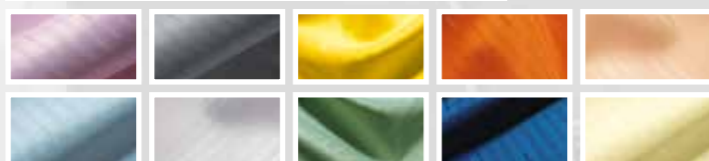

Cleanique®



RTI models in the multi-bed room and on the intensive care unit.

One telescopic screen can be used to screen off several beds, which have been previously fitted with brackets

RTI: Telescopic screen, fold-down and swing-out, self-supporting

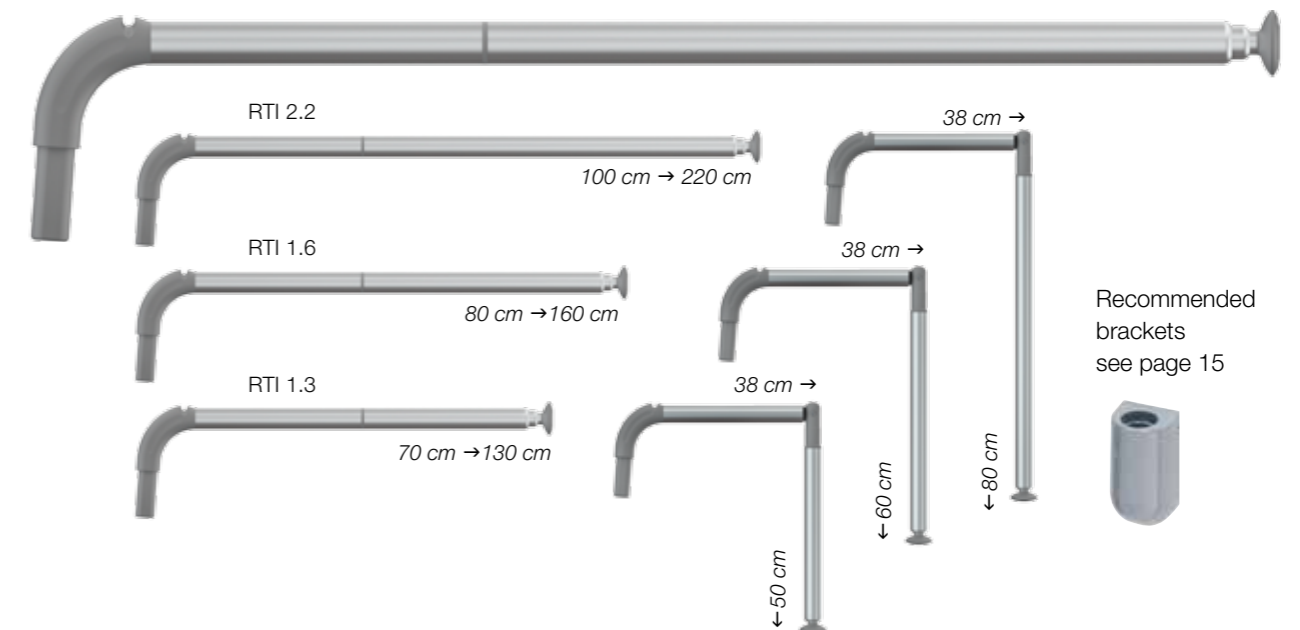

Material

ropimex® telescopic screens are made of anodised aluminium, high-quality, glass-fibre reinforced plastics. Easy to clean and to disinfect.



Model	Telescopic screen extension	Weight	Rings	Recommended curtains (see p. 22-23)
RTI 1.3	130 cm	0,6 kg	10	TCS 121, TCS 122, TCS 123, CQ 121, CQ 122
RTI 1.6	160 cm	0,7 kg	13	TCS 151, TCS 152, TCS 153, CQ 151, CQ 152
RTI 2.2	220 cm	0,8 kg	17	TCS 211, TCS 212, TCS 213, CQ 211, CQ 212

VR: Curtain rings



ropimex® curtain rings are always included with telescopic screens, telescopic arms and telescopic screen cubicles. Curtain rings can also be supplied separately. Standard colour: grey.



If they are loaded they release themselves from the eyelets of the curtains and therefore avoid injuries and damage to the system.

Telescopic arms

RTH

with hooks
fold-down and swing-out
- not self-supporting -



telescopes
disinfectable

Curtains with
disinfectant
washable

Used in combination with a height-adjustable ceiling mount RST or with an end support (GL), with the longest telescopic arm RTH 350 you can achieve a screen length of 350 cm. With the RTH models and the ceiling mounts you can divide up any room just how you want it.



If the GL cannot be mounted, e.g. on the window, a ceiling mount is used

RTH: Telescopic arms, with hooks fold-down and swing-out

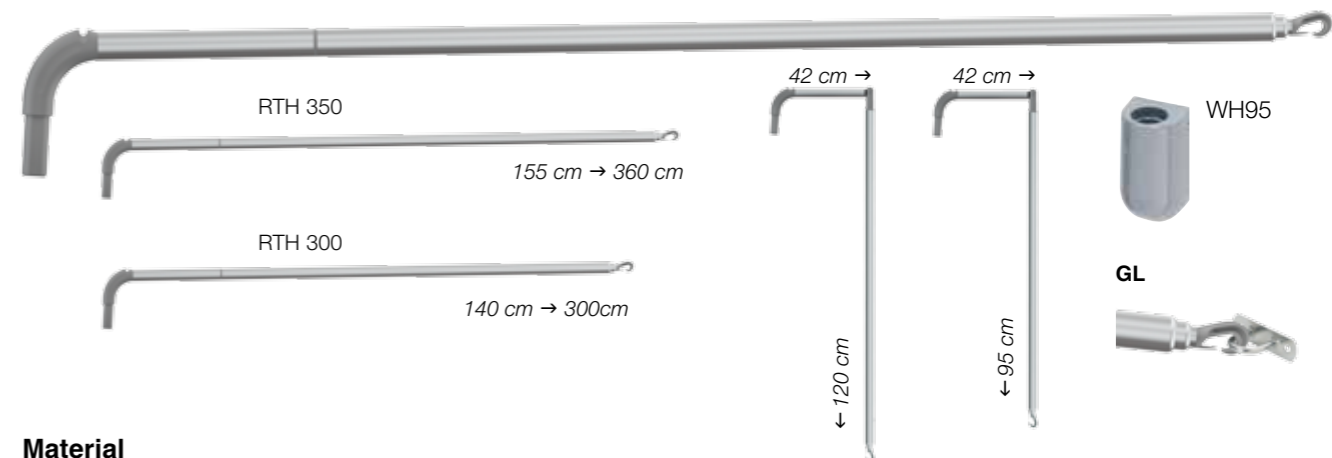

Material

ropimex® telescopic screens are made of anodised aluminium, high-quality, glass-fibre reinforced plastics. Easy to clean and to disinfect.



Model	Telescopic screen extension	Weight	Rings	Curtains	Wall mount
RTH 300	300 cm with hook at the distal end	1,0 kg	25	TCS 330	WH 95 with end support GL
RTH 350	350 cm with hook at the distal end	1,1 kg	30	TCS 390	WH 95 with end support GL

RST: adjustable ceiling mounts

Modell	Extension	Room height
RST 4	45 - 75 cm	245 - 275 cm
RST 8	75 - 135 cm	275 - 335 cm
RST 10*	110 - 200 cm	335 - 400 cm

*not illustrated

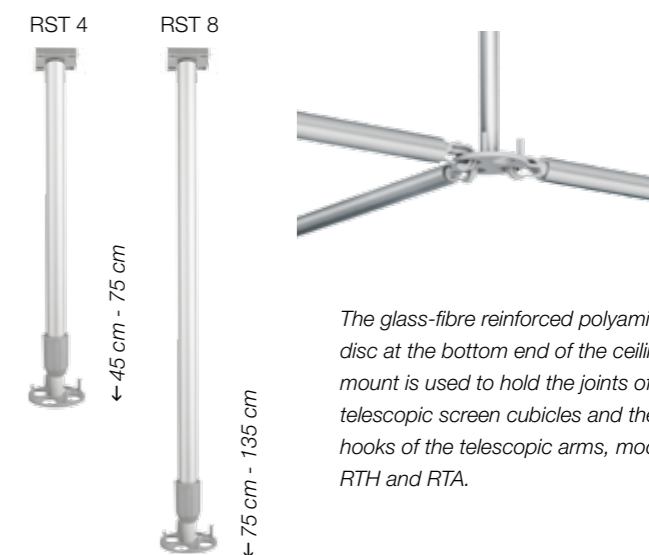

The glass-fibre reinforced polyamide disc at the bottom end of the ceiling mount is used to hold the joints of the telescopic screen cubicles and the hooks of the telescopic arms, models RTH and RTA.

Ceiling mounts Brackets

WH - Wall brackets
GSH - Brackets for
equipment rails



WH: Wall brackets for telescopic screens



Model		Dimensions
WH 95	Wall mounting for all telescopic screens, die-cast aluminium, concealed screws, adjustable to compensate for unevenness of the wall, colour coated, colours: white (RAL 9010), signal grey (RAL 7004)	Height 10 cm Width 6 cm
WH	Wall mounting for all telescopic screens	Height 16,5 cm Width 6 cm
WH/LA	Wall mounting for bridging service ducts up to 15 cm	Height 16,5 cm Width 6 cm
WH/F	Wall mounting with knurled thumb screw	Height 16,5 cm Width 6 cm

GSH: Telescopic screen brackets for equipment rails



Model		Dimensions
GSH/F	Telescopic screen bracket for equipment rail 25/10 mm, fixing by means of clamping screw	Height 13,5 cm Width 4 cm
GSH/N	Telescopic screen bracket for equipment rails, wall-supported, height-adjustable	Höhe 55 cm Width 5 cm
GSH/DK	Telescopic screen bracket with "double clamp" for equipment rails, height-adjustable	Height 55 cm Width 5 cm
GSH/95	Telescopic screen bracket for equipment rails, adjustable tilt	Height 10 cm Width 6 cm
GSH/V	Telescopic screen bracket for vertical tubes, max. 38 mm tube diameter, adjustable tilt	Height 10 cm Width 13 cm

Mobile screens

FG95



The mobile screen '95 is ready to use in only a few seconds and is quickly returned to its parked position. Its smooth and easy movement, low weight and high degree of stability ensure simple handling.

The mobile screen, fitted with one or two telescopic screens, is ideal for mobile screening, e.g. for corridor occupancy, in multi-bed rooms, in the outpatients department or at the gynaecology chair.



Mobile screen '95 with one or two telescopic screens in use

FG95 trolley

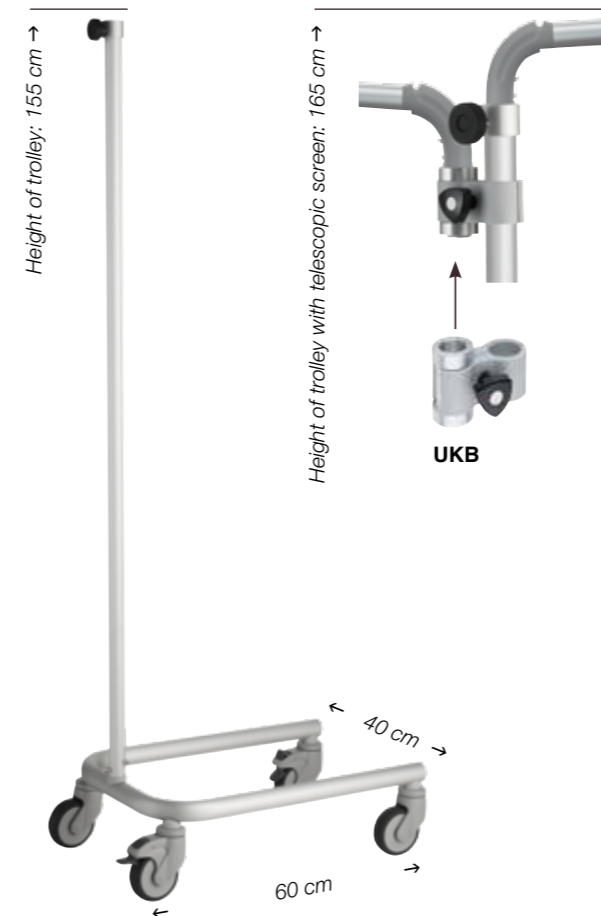

Model	
FG95	Trolley , 155x60x40 cm (H/D/W), 4 castors ø 100 mm, 2 of which are lockable. Aluminium anodised, glass-fibre reinforced polyamide, corrosion-resistant, disinfectable.
LA	Electrically conductive castors available for an extra charge.
UKB	Universal clamp for holding a second telescopic screen. All telescopic screens in the "RTI" series can be used in the FG 95 trolley.

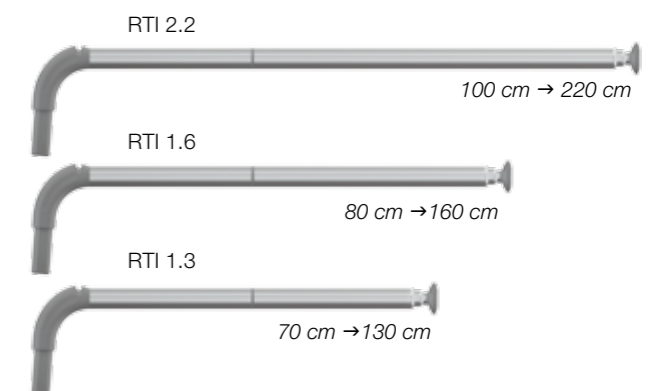

We recommend the following fitout:



Model	With one telescopic screen	Extension	Curtains
RTI 2.2	Telescopic screen, fold-down	220 cm	TCS 212, CQ 212

Model	With two telescopic screens	Extension	Curtains
RTI 2.2	Fold-down telescopic screen, (can only be used in the trolley, not suitable for the UKB clamp)	220 cm	TCS 212, CQ 212
RTI 1.6	Telescopic screen, fold-down	160 cm	TCS 152, CQ 152
RTI 1.3	Telescopic screen, fold-down	130 cm	TCS 122, CQ 122
UKB	Universal clamp for use of a second telescopic screen, telescopic screens: RTI 1.3, RTI 1.6		

Vario rail system

RVS



RVS in the admissions department



Mounting above the lintel

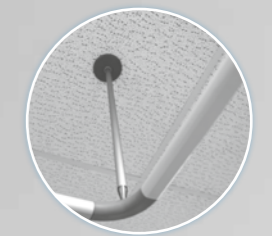

Connection cassette ceiling

One system – any number of options!
Slanting walls? Acute angle? No problem!

We supply wall connectors, which can be continuously adjusted up to 180 degrees – and compensate for virtually any asymmetry in the architecture. Move or renovation: The rail system is designed to adapt to new requirements at any time.



Recommended curtains (see p. 22-23)

Trevira®CS Bioactive

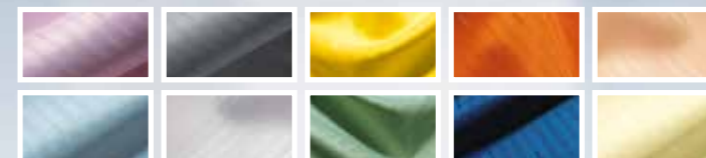

Cleanique®



Vario rail system

RVS



- quickly assembled
- mega variable
- durable

Easy ordering: A simple sketch suffices!

Simply prepare a hand-drawn, dimensioned sketch of the required room layout, enter the widths and lengths as well as the room height and the required headroom.

We will put together the complete system for you.

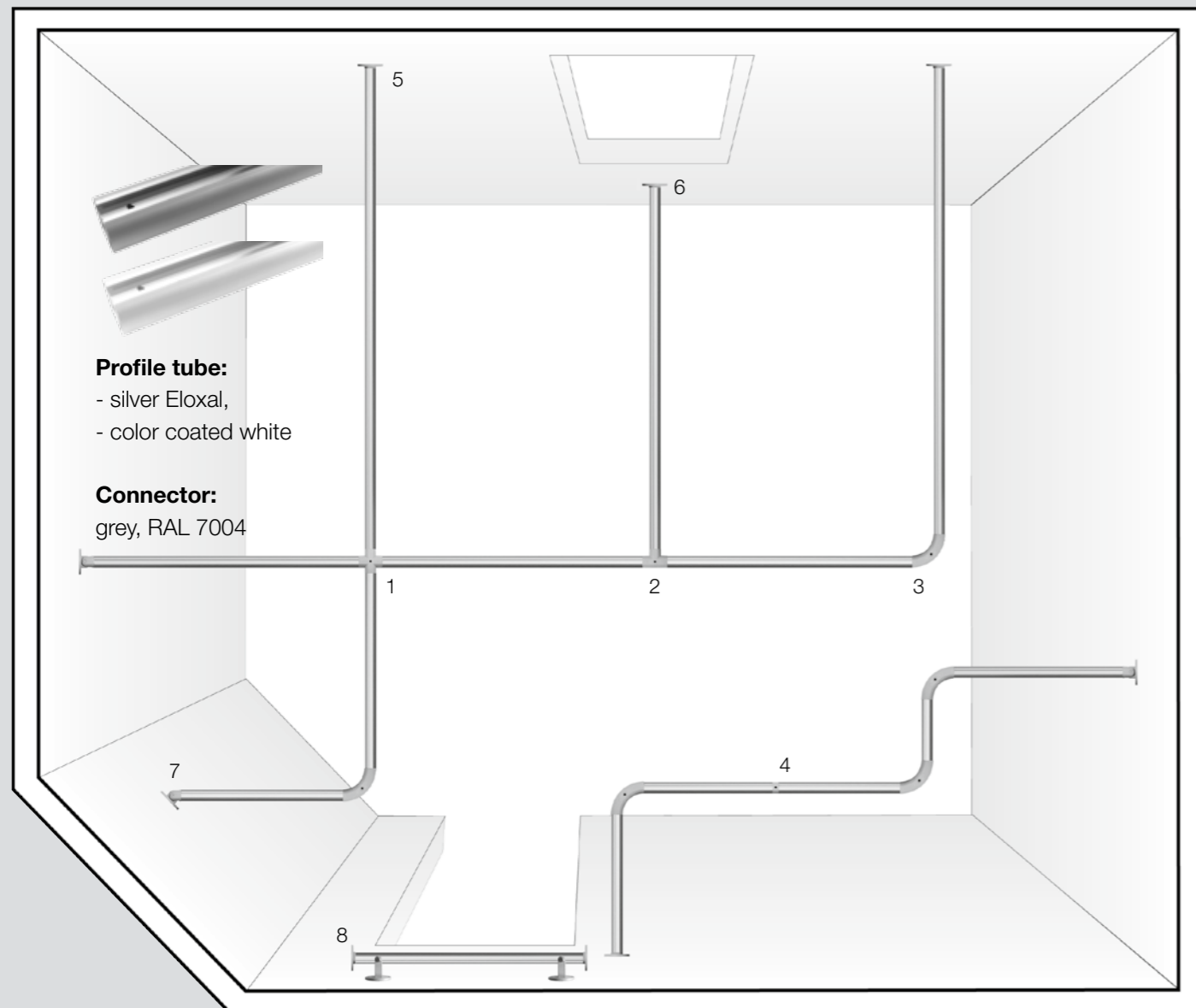

Profile tube:
- silver Eloxal,
- color coated white

Connector:
grey, RAL 7004



Curtain ring RVS/VR

Curtain ring made of unbreakable polyamide: Releases itself from the curtain eyelet if overloaded (approx. 2 kg).



Ringstopper: for fixation of a curtain ring at the beginning or the end of the rail.



Silicone cover profile RVS/AP

With the RVS connectors, you can create cabs as you wish

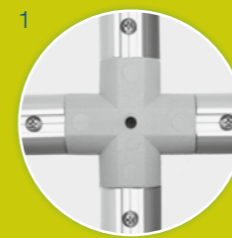

Cross-connector (RVS/KV)

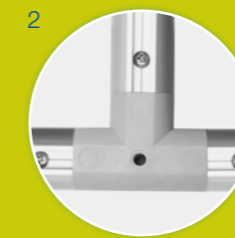

T-connector (RVS/TV)



Corner solutions without sharp edges: with the curved connector RVS/BV (radius 60 mm)

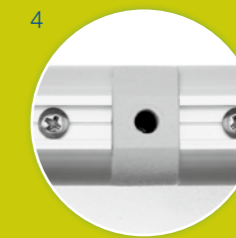

Change later: simply disconnect the profile tube and install the connector of your choice, e.g. linear connector RVS/LV

RVS-Wall connections - for every requirement



Free-standing end:
End cap RVS/EK stops the curtain.



Straight at the wall:
Wall connector RVS/WA



Sloped walls, acute angles:
the Vario wall connector RVS/WAV compensates for and levels out asymmetries up to 180° and length differences up to +/- 5 mm.

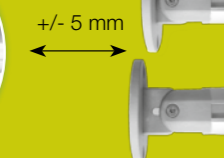

Flexible to the ceiling - RVS ceiling connectors



Mounted directly under the ceiling: with ceiling bracket RVS/DH (distance from top of ceiling to bottom of rail approx. 6 cm).



Suspended at headroom height: with the adjustable ceiling mount (+/- 20 mm) RVS/DS.



For free-standing end RVS rails: adjustable double ceiling mount (+/- 2cm) RVS/DDS.

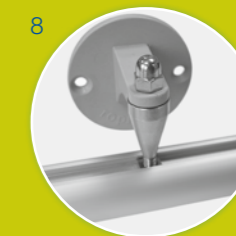

Easy above the lintel: e.g. at windows or doors using the wall connector RVS/WAS



Anchoring on profile rail: possible along the whole length by means of square nut; for adjustable ceiling mount RVS/DS or with ceiling bracket RVS/DH. Max. spacing: 2 m.

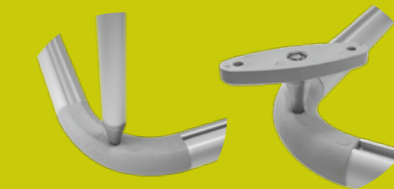

Anchoring via all connectors: Standard threaded hole for screwing in the adjustable ceiling mount RVS/DS or the ceiling bracket RVS/DH ensures firm support.

Curtains

Trevira®CS Bioactive

ropibel®

Flame-resistant curtains can save lives!

ropimex® multifunctional textiles have more than proven themselves in practical application – whether here with us or in Tahiti or even Yakutsk. We only use flame retardant qualities that will meet even the most stringent hygiene requirements. The longevity of our materials meanwhile guarantees a most cost-effective price-performance ratio.



Trevira®CS Bioactive

TCS: ropimex®-curtains made of Trevira®CS Bioactive have been tried and tested for 20 years

Permanently flame-retardant and anti-microbial

- 100% Polyester, permanently flame-retardant
- the fabric meets fire class B1 as per DIN 4102-1 and B-s1 d0
- with the fire resistance indelibly anchored in the molecular structure
- Trevira®CS Bioactive is permanently anti-microbial
- permeable to daylight, ideal if there are several partitions in a room
- light-fast, dimensionally stable, crease-resistant, long service life
- certified to Oeko-Tex standard 100
- fabric weight: ca. 115 g/m²



Size table

	Width	x	Height in cm
TCS 110	110	x	175
TCS 121	140	x	120
TCS 122	140	x	140
TCS 123	140	x	175
TCS 151	170	x	120
TCS 152	170	x	140
TCS 153	170	x	175
TCS 200	200	x	175
TCS 211	230	x	120
TCS 212	230	x	140
TCS 213	230	x	175
TCS 215	250	x	175
TCS 217	270	x	175
TCS 300	300	x	175
TCS 330	330	x	175
TCS 360	360	x	175
TCS 390	390	x	175
TCS 420	420	x	175
TCS 460	460	x	175
TCS 500	500	x	175

Special designs on request



Available in 10 colours

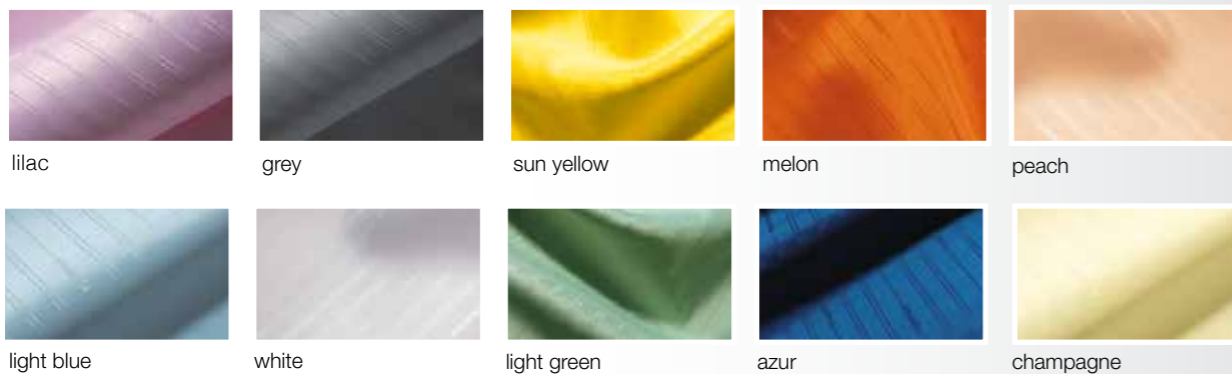

ropibel®

ropimex®-ropibel - made of Polyester
The feel-good fabric



Permanently flame-retardant, anti-microbial, Acoustic properties class C

- 100% Polyester, permanently flame-retardant
- the fabric meets fire class B1 as per DIN 4102-1, M 1 Non Feu (B+F+E), Classe (I), BS 5'867 (GB) and EN 13 773 Classe 1
- with the fire resistance indelibly anchored in the molecular structure
- permanently anti-microbial
- Acoustic properties class C
- permeable to daylight, ideal if there are several partitions in a room
- light-fast, dimensionally stable, crease-resistant, long service life
- certified to Oeko-Tex standard 100
- fabric weight: ca. 260 g/m²



Size table

	Width	x	Height in cm
RB 1716	170	x	160
RB 1718	170	x	180
RB 1720	170	x	200
RB 2316	230	x	160
RB 2318	230	x	180
RB 2320	230	x	200
RB 2716	270	x	160
RB 2718	270	x	180
RB 2720	270	x	200
RB 3316	330	x	160
RB 3318	330	x	180
RB 3320	330	x	200
RB 4016	400	x	160
RB 4018	400	x	180
RB 4020	400	x	200
RB 5016	500	x	160
RB 5018	500	x	180
RB 5020	500	x	200

Special designs on request

Available in 4 colours

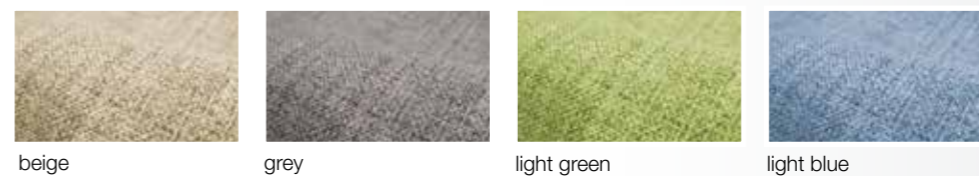

*Request our test report concerning disinfectant resistance based on DIN EN ISO 2812-4:2007.

Curtains

Zerøtex

Cleanique

staph CHEK

Zerøtex

ropimex® Zerøtex - non-woven disposable curtain: saves time and money

For hygiene-sensitive environments

Standard curtains eyeleted.
Suitable for ropimex RTS and RTI
Telescope Systems or RVS Rail System

- Non-woven
- 100% polypropylene (PP)
- Ideal for hygiene-sensitive environments
- In health facilities
- In public institutions with a high level of public access
- Complies with fire class B-s1 d0 tested according to DIN EN 13501
- Recyclable
- Skin friendly
- Completely safe in accordance with physiological standards
- Resistant to almost all solvents
- Dispose of recyclable material after use
- Available in 70 g/m²
- Fabric width: 210 cm

Size table

	Width x Height in cm	
	suitable for	
Z1514	150 x	140
Z1516	150 x	160
Z1517	150 x	175
Z1814	180 x	140
Z1816	180 x	160
Z1817	180 x	175
Z2114	210 x	140
Z2116	210 x	160
Z2117	210 x	175

Minimum purchase: 25 units per colour and size

Available in 5 colours



blue



yellow



lightgrey



green



cream

Cleanique

CQ ropimex®- seamless Hygienic-curtain of the new generation

Cleanique®

Top level hygiene:

- antimicrobial activity
- beautiful draping properties
- soft feel
- approved for skin contact in accordance with FDA (ISO 10993)
- flame-retardant, fire class M1
- thermoplastic polyether polyurethane
- water-repellent
- light-fast
- resistant to rubbing
- tear-proof
- recyclable
- seamless
- durable
- non-stick
- fabric weight: ca. 270 g/m²

Size table

	Width	x	Height in cm
CQ108	100	x	80
CQ128	120	x	80
CQ121	140	x	120
CQ122	140	x	140
CQ123	140	x	170
CQ151	170	x	120
CQ152	170	x	140
CQ153	170	x	170
CQ211	220	x	120
CQ212	220	x	140
CQ213	220	x	170
CQ1218	120	x	180
CQ1220	120	x	190
CQ1420	140	x	190
CQ1620	160	x	190
CQ1820	180	x	190
CQ2020	200	x	190
CQ2220	220	x	190
CQ2420	240	x	190
CQ2720	270	x	190
CQ3020	300	x	190
CQ3320	330	x	190

Special designs on request

disinfectable

Curtains with disinfectant washable

30°C

Available in 3 colours

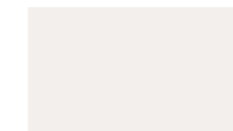

velvet-white



sky blue



orange

staph CHEK

VH/C ropimex®- curtains made of staph CHEK

staph CHEK, the fabric for sanitary blocks, showers and bathrooms

- Stable and compact
- anti-bacterial
- flame-retardant, fire class M2
- ideal for use as a shower curtain
- skin-friendly / does not stick to the body
- anti-static
- impervious to liquids
- staining- and soiling-resistant
- in areas where careful treatment cannot be guaranteed because of exceptional circumstances
- simply wipe down with a sponge and household cleaner
- durable
- fabric weight: ca. 330 g/m²

Size table

	Width	x	Height in cm
VH/C 100	100	x	80
VH/C 120	120	x	80
VH/C 121	140	x	120
VH/C 122	140	x	140
VH/C 151	170	x	120
VH/C 152	170	x	140
VH/C 211	220	x	120
VH/C 212	220	x	140

Special designs on request

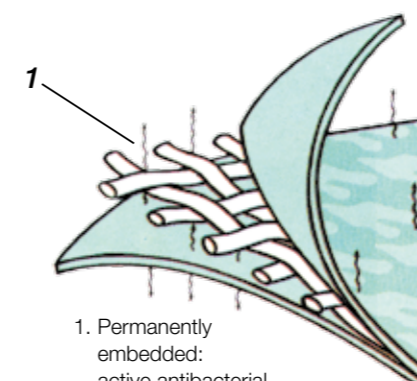

1. Permanently embedded: active antibacterial components

Available in 5 colours



light blue

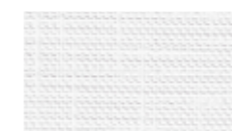

white



yellow



beige



mint

*Request our test report concerning disinfectant resistance based on DIN EN ISO 2812-4:2007.

Folding screens

RFW

wall-mounted



Folding screen wall-mounted



Infill panels: non-see-through but translucent

Non-see-through 360° hinges. Tearproof

10 years warranty on hinge system



RFW wall mounted in park position

Flexibly usable as a screen or partition in the hospital and care sector, the robust and impact-resistant folding screen is positioned in seconds and parked back against the wall after use. The number of leaves can be extended at a later date. Non-see-through but translucent leaf infill material with high-quality aluminium profile creates a pleasant, light atmosphere.

Modern leaf designs, available in different colours, give the folding screen an individual touch.

Available in 10 colours and 4 design options

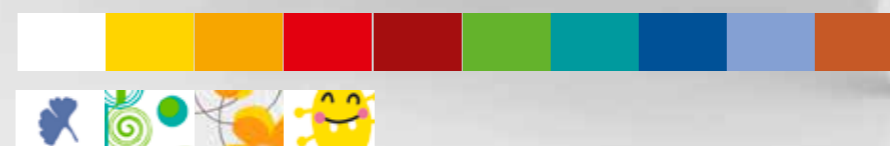

Folding screens

RFW

mobile



RFW in parking position

Mobile folding screen: the classic example of adaptability and versatility. Mobile folding screens, which are used here today and there tomorrow, offer the greatest possible spatial flexibility in everyday care and treatment work: in hospitals and care of the aged, in doctors' surgeries as well as in clinical rooms. At the same time you guarantee patients the necessary discretion. Position, fold open, fold together after use and roll away – care of the easy-clean surfaces made of aluminium and scratch-resistant polycarbonate is just as easy as the handling. Visually the design award-winning folding screens contribute to the general feeling of well-being – in the doctor's surgery or in a clinic.

Available in 10 colours and 4 design options

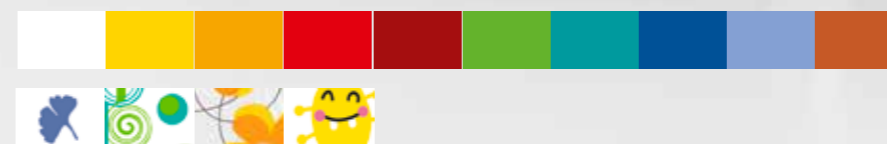

Folding screens

RFW

Technical data



wall mounted



Non-see-through 360° hinges.
The RTC unit (ropimex®-Turn&Connect) enables 360° leaf rotation.

Accessories available:
Clamp set for service rail
Spacer for wall-mounting



mobile



Well-designed and stable



Note: Mounted on a trolley, the folding screen is only mobile. It is therefore not possible to convert it to a wall-mounted screen or to fix it to an equipment rail or column.



column-mounted



Possibility to fix until 4 folding walls



Folding screen for wall-mounting RFW		Screen	open width
Leaf width	30 cm	3-leaf	90 cm
Heights	145 / 165 / 185 cm	4-leaf	120 cm
Weight	3,00 / 3,50 / 4,00 kg/leaf	5-leaf	150 cm
Frame	Frame and hinged profiles: extruded aluminium (Al Mg Si 05), anodised surface, connecting screws: V2A stainless steel	6-leaf	180 cm
Plastic parts	PA 6 GF 15, polyamide with 15% glass fibres	7-leaf	210 cm
Infill panels	Polycarbonate, 2 mm, white, translucent, flame resistant, construction material class B1, DIN 4102-01, extremely impact resistant	8-leaf	240 cm
		9-leaf	270 cm
Care	commercially available cleaning product and disinfectant*	10-leaf	300 cm



Accessories

Spacer set for wall fixing RFW-WA

Spacer for wall fixing, standard spacing 100 mm, special length to customer-specified dimensions possible up to 400 mm

Clamp set RFW-KLS

Clamp set for fixing to double-track standard rail

Trolley



Trolley for folding screen

The mobile version with max. 10 leaves enables mobile use. Please note: mobile folding screens are available in heights **145** and **165** cm only.

RFW-FG4	Height 145 cm, weight 14 kg
RFW-FG6	Height 165 cm, weight 15 kg
Trolley base	52 x 59 cm
Folding screen	For description and screen length see above (RFW)

Stainless steel column



Stainless steel column for folding screen

Ideal wherever wall-mounting is not possible. Stainless steel column with dimensions 5 x 5 cm. Available in 3 heights.

RFW-ES4	Height 145 cm, weight 5,00 kg
RFW-ES6	Height 165 cm, weight 5,50 kg
RFW-ES8	Height 185 cm, weight 6,20 kg
Upright	5 x 5 cm
Folding screen	For description and screen length see above (RFW)

*Request our test reports concerning the disinfection based on DIN EN ISO 2812-4:2007.

Folding screens

RFW

Colours and designs

Available in 10 colours and 4 design options

Standard:
white
translucent

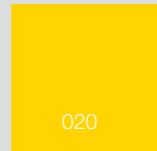
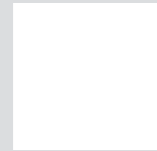

golden yellow

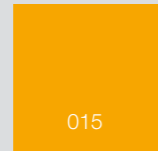

yellow-orange

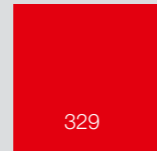

carnation red

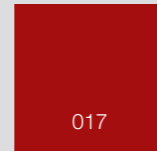

cherry red

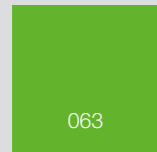

lime green

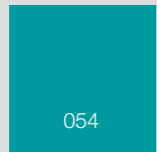

turquoise

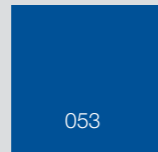

light blue

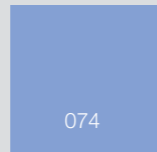

blue-grey

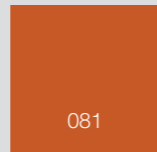

copper-brown

Plain



- Optional continuous or leaf-wise covering
- Standard colour: white, translucent
- Film overlay on both sides, translucent



Plain

Retro design



- Can be combined leaf-wise with PLAIN
- Film overlay on one side
- The white-translucent polycarbonate enables the design to show through at the back
- Specify whether right or left-hung



green blue copper yellow red

Design Flowers



- Can be combined leaf-wise with PLAIN
- Film overlay on one side
- The white-translucent polycarbonate enables the design to show through at the back
- Specify whether right or left-hung



green blue copper yellow red

Ginkgo design



- Film overlay on one side
- The white-translucent polycarbonate enables the design to show through at the back
- Specify whether right or left-hung
- Can be combined leaf-wise with PLAIN



lime green blue-grey yellow-orange cherry red

Monster design



- Can be combined leaf-wise with PLAIN
- Film overlay on one side
- The white-translucent polycarbonate enables the design to show through at the back
- Specify whether right or left-hung

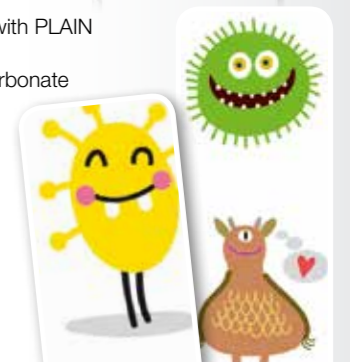

Butterfly Folding wall

RBF



Ideal for mobile shielding in addition to the RFW

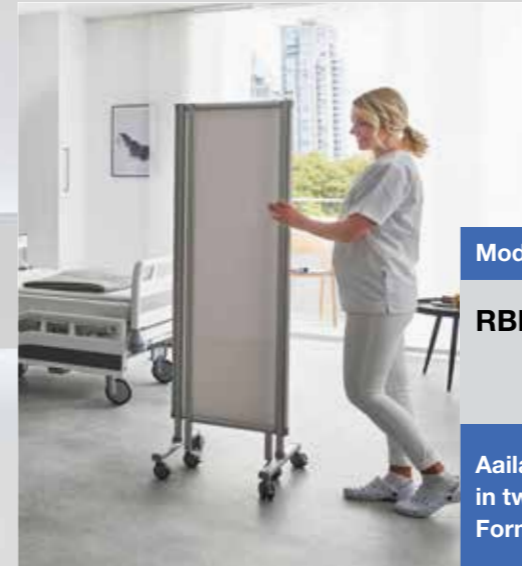

Model	ropimex® Butterfly Folding wall
RBF	3-leaf made in polycarbonate, with middle leaf centred on double T-leg and 360° rotatable leaves on either side, fold-away.
Available in two Formats	RBF: Leaf widths 45/50/45 cm, height 165 cm, weight 15,60 kg RBF200: Leaf widths 65/70/65 cm, height 165 cm weight 18,00 kg

Material	Frame and hinged profiles: extruded aluminium (Al Mg Si 05), anodised surface, connecting screws: V2A stainless steel, Infill panels Polycarbonate, 2 mm, Plastic parts PA 6 GF 15, polyamide with 15% glass fibres
Colour	white, translucent



Sticker bows



Monsters:
Especially for yours young patients

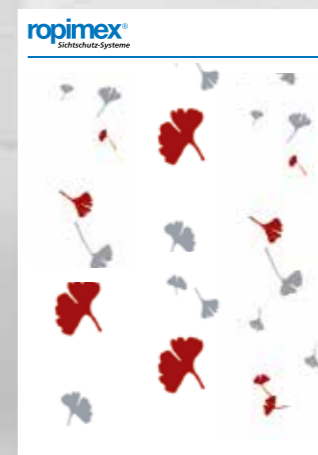

Ginkgo



Folding wall

DIVI max

Wall mounted
Mobile
Column mounted

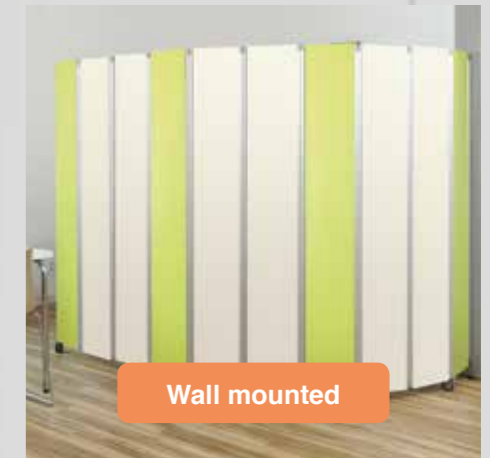

Wall mounted

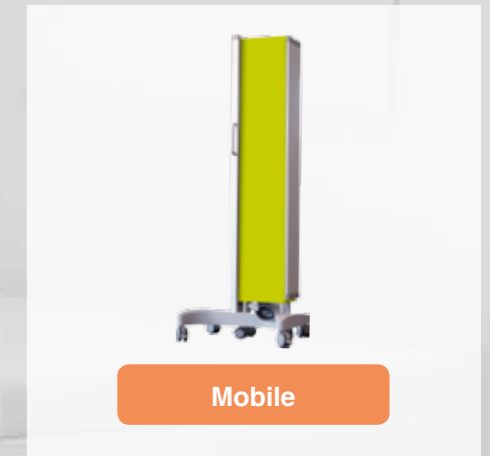

Mobile

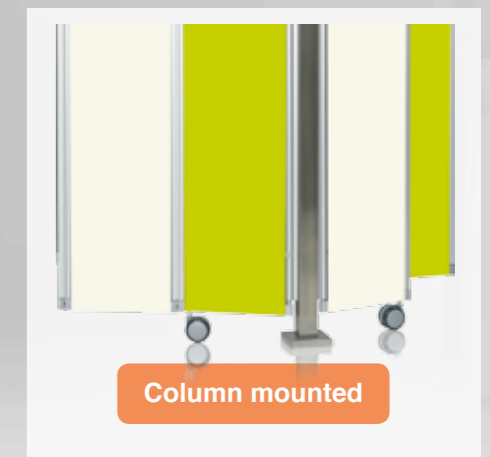

Column mounted

This room divider offers the greatest possible flexibility for hospitals and clinics. DIVI max is available in 3 versions : attached to the wall, mobile, or attached to a column. The board (front and back) is made from a high-quality HPL (High-Pressure-Laminate) by Resopal with stable frame construction. Easy to clean and/or to disinfect.* At the reception. In the foyer. Wherever you quickly need to create an area enabling a minimum of peace and maximum privacy.

*Request our test reports concerning the disinfection based on DIN EN ISO 2812-4:2007.

Available in 5 colours

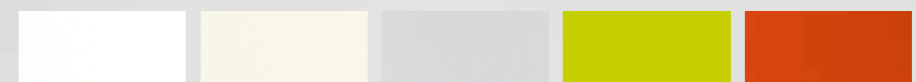

Folding wall

DIVI max

Technical data

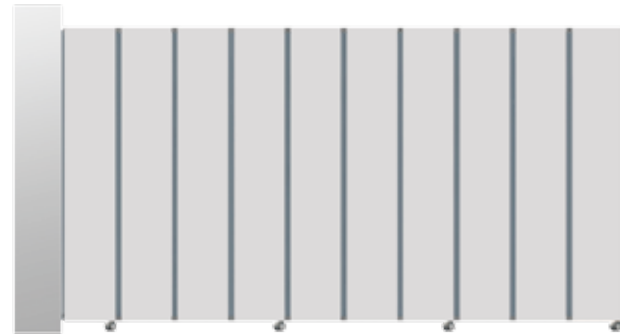

Wall mounted



Non-see-through 360° hinges. The RTC unit (ropimex®-Turn&Connect) enables 360° leaf rotation.

Accessories available:
Clamp set for service rail
Spacer for wall-mounting



Model DX - DIVI max - wall mounted

Width / panel	30 cm
Heights	150 / 180 cm
Weights	3,73 / 4,06 kg/panel
Frame	Frame and hinge components: extruded aluminium (Al Mg Si 05), anodized surface, fastening : V2A Stainless steel
Plastic parts	PA 6 GF 15, polyamide with 15% glass fibres
Panel	high-quality HPL (High-Pressure-Laminate) by Resopal
Care-Instructions	clean with disinfectants in current general use*

Width when opened out

3-panels	90 cm
4-panels	120 cm
5-panels	150 cm
6-panels	180 cm
7-panels	210 cm
8-panels	240 cm
9-panels	270 cm
10-panels	300 cm



Accessories

Braces for wall mounting Set DX-WA	braces for wall mounting (set of 2 pcs). Lenght 100 mm, specific sizes available upon request
Clamps-Set DX-KLS	clamps for track mounting (set of 2 pcs)

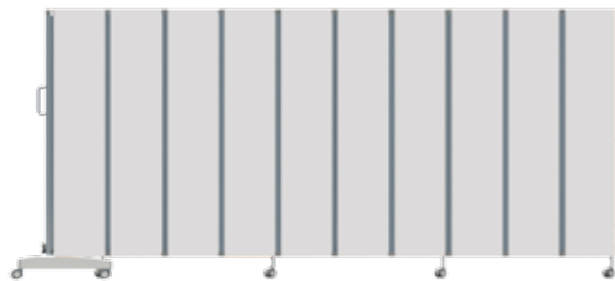

Mobile



Note: Mounted on a trolley, the folding screen is only mobile. It is therefore not possible to convert it to a wall-mounted screen or to fix it to an equipment rail or column.

Trolley

Trolley for folding wall DIVI max

To ensure the best possible stability, the mobile version is available with up a maximum of 10 panels only and the height is 163 cm.

Height 163cm, weight of the feet: 17,00 kg

Size of base: 52 x 59 cm

Folding wall: description and width: see above



Column mounted

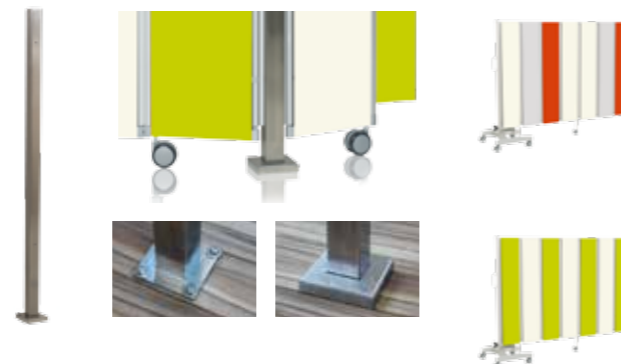

Possibility to fix until 4 folding walls

Stainless steel column

DX-ES Stainless steel column for folding DIVI max

Perfect for anywhere where there are no attachment points. This column has 4 sides each 5 cm, available in 2 heights

DX-ES5: height 150cm, weight: 5,20 kg

DX-E85: height 180 cm, weight: 6,02 kg

5 x 5 cm

Folding wall: description and width: see above

DIVI max available in 5 colors

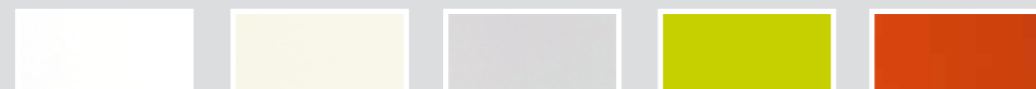

Snow White

Alabaster

Silver Grey

Carambola

Paprika

*Request our test reports concerning the disinfection based on DIN EN ISO 2812-4:2007.

Lightweight paravents

RLP



CE



ropimex®-Lightweight paravents are convincingly easy to handle. The 360° non-see-through hinges each leaf enable each leaf to be moved into the required position. Standard fabric covering with staph CHEK fabric, with Trevira®CS for an additional charge.

Please note: Paravent leaves must always be positioned at an angle to each other, unless the ropimex® base (model RLP/C) is used.



RLP in retirement



Folded together, a storage space can be found anywhere



Base for stabilising a single or several paravents to make use of the open width or to form a routing system



Covering: without folds. Opaque 360° hinges.



Leaf-wise colour selection also possible.



Standard version without castors. Can be supplied with castors for an additional charge.

Covering (see page 23)

staphCHEK

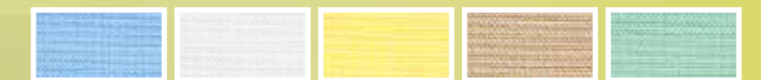

Model	ropimex®-lightweight paravent	Leaf	Weight	Width	Height
RLP/2	Lightweight paravent, 2-leaf	2	3,8 kg	100 cm	165 cm
RLP/3	Lightweight paravent, 3-leaf	3	5,7 kg	150 cm	165 cm
RLP/4	Lightweight paravent, 4-leaf	4	7,6 kg	200 cm	165 cm
RLP/5	Lightweight paravent, 5-leaf	5	9,5 kg	250 cm	165 cm

Material	Frame: Aluminium design profiles, natural-anodised, foot and cover caps made of polyamide, light grey. Optional: Plastic castors, black
Covering	Standard covering staph CHEK. staph CHEK fabric is antibacterial, flame-resistant, self-extinguishing, antistatic and durable. It does not have to be washed. Stains are easily wiped off with a sponge and household cleaning products.
Colours	light blue, white, yellow, beige, mint

Lightweight paravents

RLP/C

Base

RLP/C base to stabilise the paravent



Base for holding up to 4 paravents



1 paravent at right-angles

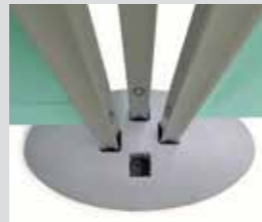

3 paravents in the base



4 paravents in the base



2-leaf paravent in the base



Paravents in a row as a routing system

Model	ropimex®- base		
RLP/C	Base to stabilise the paravent when opened out straight (use of the open width) and/or for holding several paravents (max. 4 per base), as a partition or for setting up a routing system		
Material	Glass-fibre reinforced polyamide (GRP)		
Dimensions/Weight	8 x 15 x 30 cm (H x W x D), weight 1.3 kg		
Variations	<p>1 Paravent in a line</p>	<p>1 Paravent at right-angles</p>	<p>up to 4 paravents possible</p>

Lightweight paravents

RLP/W

Wall mounted

RLP/W for wall-mounting



- Accessories available:
- Clamp set for service rail
 - Spacer for wall fixing
 - Upright made of stainless steel



Model	ropimex®- Lightweight paravent with wall connector	Leaf	Weight	Width	Height
RLP/W2	with wall connector, on castors	2	3,8 kg	100 cm	165 cm
RLP/W3		3	5,7 kg	150 cm	165 cm
RLP/W4		4	7,6 kg	200 cm	165 cm
RLP/W5		5	9,5 kg	250 cm	165 cm

Accessories

RLP-WA	Spacer for wall fixing, standard spacing 100 mm, special length to customer-specified dimensions possible up to 400 mm
RLP-KLS	Clamp set for fixing to double-track standard rail
RLP-ES	Upright made of stainless steel for RLP/W, for free-standing installation in the room, height 1,650 mm

Butterfly Paravent

RBP



CE

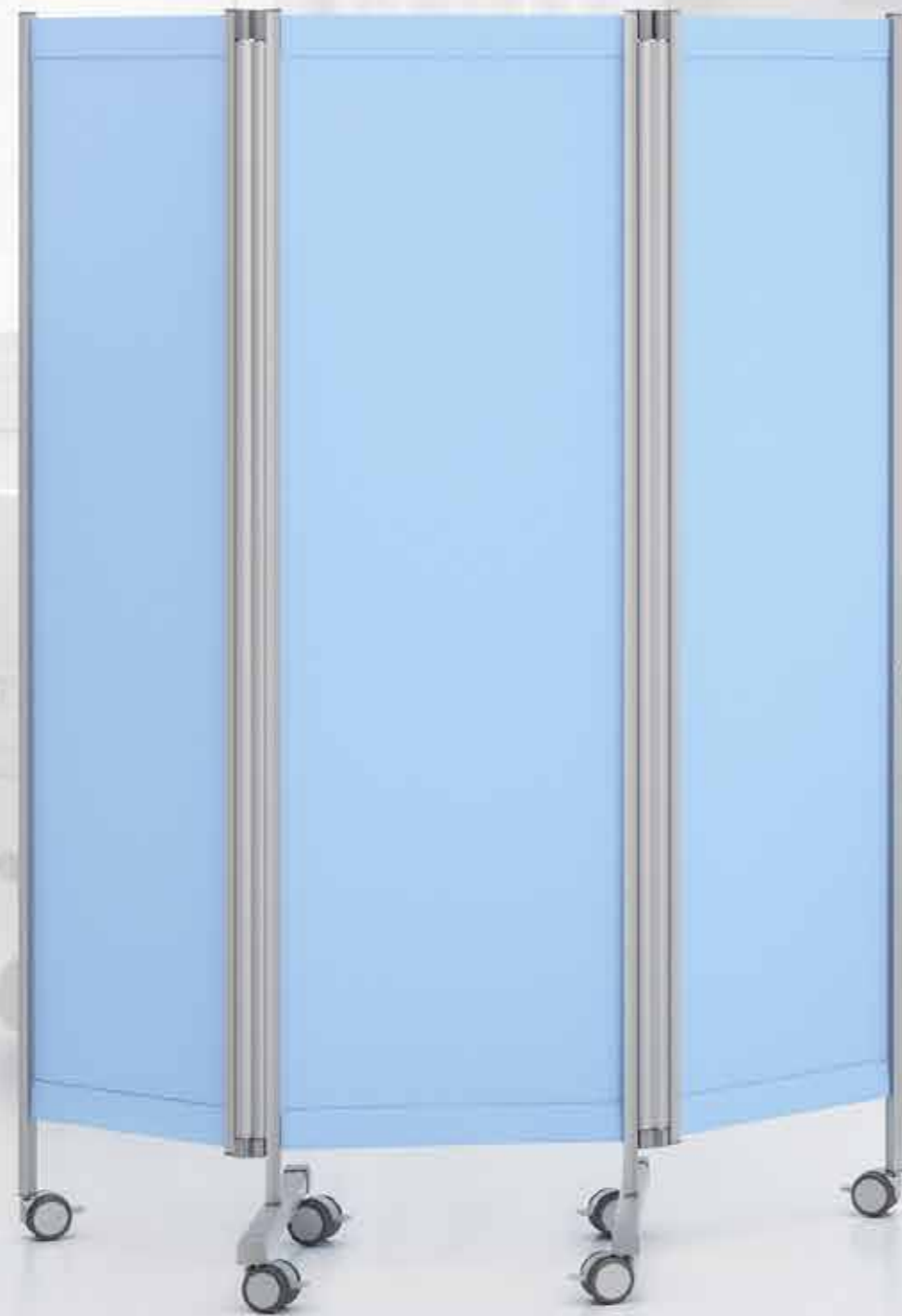

Butterfly paravent, mobile, ideal for screening the bottom ends of beds



Model	ropimex® butterfly paravent
RBP	3-leaf, with middle leaf centred on double T-leg and 360° rotatable leaves on either side, fold-away
Dimensions	RBP: Leaf widths 45/50/45 cm (140 cm), height 165 cm, weight 8.9 kg RBP200: Leaf widths 65/70/65 cm (200 cm), height 165 cm, weight 11.0 kg

Material	Frame: Aluminium design profiles, natural-anodised, foot and cover caps made of polyamide, light grey. Plastic castors, black
Covering	Standard covering staph CHEK. staph CHEK fabric is antibacterial, flame-resistant, self-extinguishing, antistatic and durable. It does not have to be washed. Stains are easily wiped off with a sponge and household cleaning products.
Colours	light blue, white, yellow, beige, mint

Covering (see page 23)

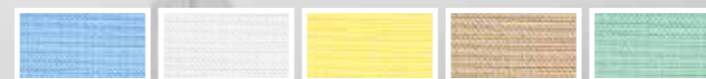

Folding curtain

PLiO



CE



PLiO in hospital



Ideal room divider



PLiO® is quickly usable and just as quickly pushed together again to save space.

PLiO® is a flame-retardant folding curtain that was developed for hypersensitive facilities. PLiO® is ideal for users whose hygiene concept opposes the use of classic curtains that need to be regularly cleaned, usually by external service providers. PLiO® is quickly usable and just as quickly pushed together again to save space, and that without expanding again. The surfaces are smooth and suitable for all commercially available disinfectants. The transitions between the individual panels (connecting joints) are also smooth and flush. This helps to avoid undesirable grooves where dirt or germs could accumulate.



Folding curtain

PLiO



ropimex® HyGentle®: Product design and material combination for maximum hygiene

Smooth surface: No grooves able to accumulate dirt or germs

Joints: permanent antibacterial

Fire protection class: as per DIN EN 13501 B – s2 d0

Available in 3 colours

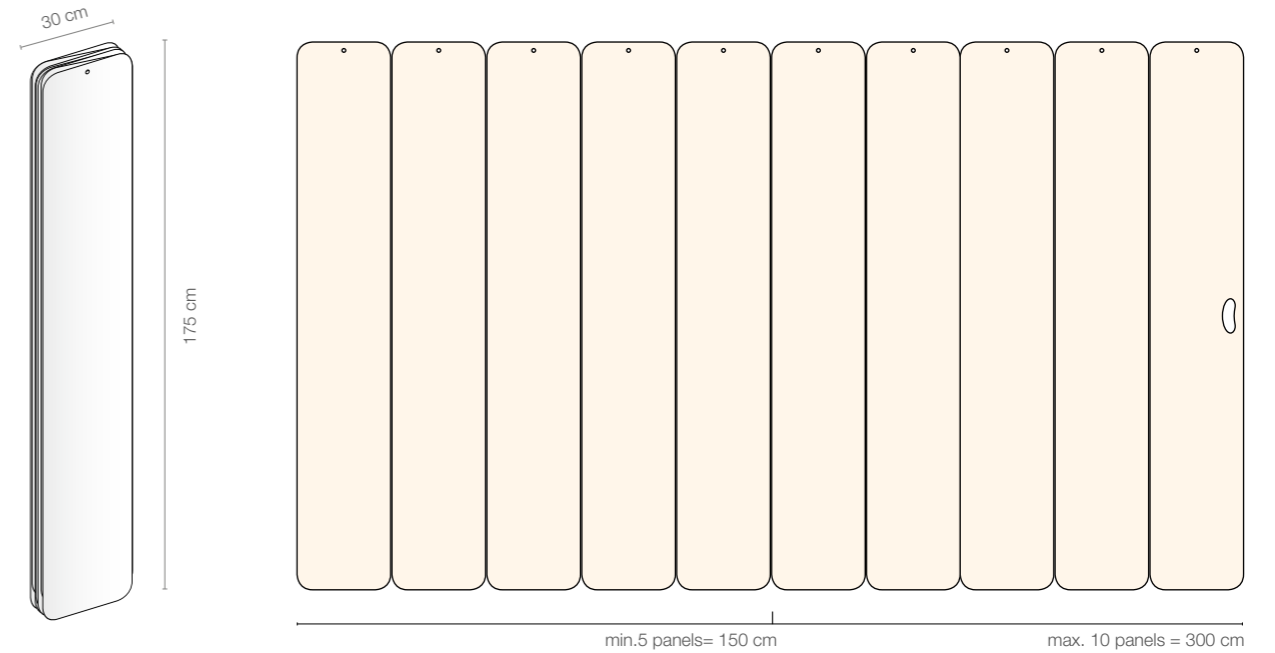

Curtain rings

Semi-open PLiO® curtain ring for curtain systems that are permanently installed and hence not freely accessible, e.g. ropimex® RVS

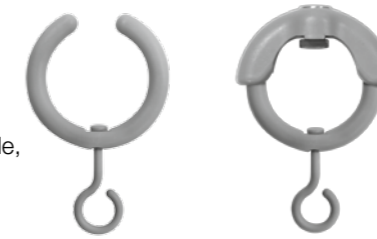

Ringstopper for fixation of a curtain ring at the beginning or the end of the rail.

In combination with the RVS Rail system generally white powder coated (see page 19-21)



Model		Coverage
PLiO/5	5-panelled	150 cm
PLiO/6	6-panelled	180 cm
PLiO/7	7-panelled	210 cm
PLiO/8	8-panelled	240 cm
PLiO/9	9-panelled	270 cm
PLiO/10	10-panelled	300 cm

Material	Panels made from hard PVC, joints from soft PVC, phthalate-free Fire protection class: as per DIN EN 13501 B – s2 d0
Dimensions	Panel width: 30 cm, Height: 175 cm, Panel weight: 310 g/panel
Care	commercially available cleaning product and disinfectant*
Colours	RAL 9010 Pure white, RAL 5014 Dove blue, RAL 6034 Pastel turquoise, *

*Colours based on RAL, colour variations are possible.

Shower splash guard Telescopic screen cubicles

RDSE RDLE RDTE
RKLE **CE**

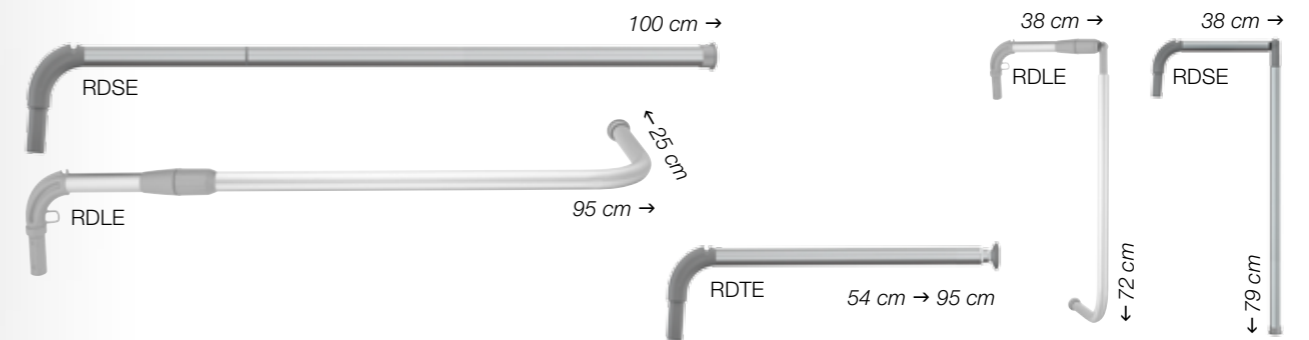

Model		Projection	Recommended curtains	Rings
RDSE	Splash guard arm swing-out and fold-down	100 cm	VH/C 100 CQ 108	8
RDTE	Splash guard arm, telescopic swing-out	95 cm	VH/C 100 CQ 108	8
RDLE	Splash guard arm, L-shaped, can be used on the right and left-hand side, side leg 25 cm, swing-out and fold-down	95 cm	VH/C 120 CQ 128	10
Wall mount	Recommended wall mount: WH, WH 95 (for a description see p.13)			
VR	ropimex®-curtain rings are always included with our telescopic screens, telescopic arms and telescopic screen cubicles. Colour: grey.			

ropimex®-Telescopic screen cubicles Model RKLE

(wall fixing)

With this space-saving model it takes just a few seconds to create a screen for washing, changing, radiotherapy or inhaling, either as a corner solution or as a U-shaped solution.



Recommended curtains (see p. 22-23)

staphCHEK



Cleanique®



Privacy screen for patients, splash guard for the care personnel. The shower splash guard saves the care personnel having to get changed and therefore makes their work easier. One splash guard can be used for several shower areas fitted with wall brackets.

Satisfied customers all over the world



Since 1976, ropimex® has been busy finding solutions to protect the privacy of the sick and those in need of care.

The telescopic screens of the early years are still in use today. From them a system developed, whose diversity, use and combination options provide a suitable solution for each and every customer.

All these properties, top advice from authorised stockists and the fastest possible delivery have secured ropimex® more than 80,000 satisfied users to date, all over the world.



For your safety



ropimex® products conform to the highest safety standards.

The telescopic screens including the trolley, the Vario rail system and the folding screens all bear the GS tested safety mark issued by the German TÜV (technical inspectorate).

ropimex® curtains made of Trevira®CS pass every fire test worldwide and are tested and certified to the Öko-Tex standard 100 Europe-wide.

ropimex® Privacy Systems - 43 years of experience in designing medical inventory for hospitals, therapy centers and care facilities. Our products meet the regulatory requirements for medical devices. The systems are designed so that a patient zone / intimate zone can be created for virtually any existing condition - stationary or mobile.

ropimex® privacy systems are the customizable accessories for medical devices such as patient beds, treatment couches and treatment chairs in medical facilities.

ropimex® privacy systems are compliant with the Swiss Privacy Policy, which requires confidential handling of patient-related data. These patient-related data also include explicit discussions between patients and patients and the preservation of privacy in treatment and patient care.



Fabric sample cards



Do you need a fabric sample card?
Just phone **0 68 21/9 12 77-0** - we will send you what you need without delay!

ropimex®

Telescopic screens | Telescopic arms | Mobile screens | Vario rail system | Curtains
Folding screens | Paravents | Folding Curtain PLiO | Shower splash guard



disinfectable
—
washable

